

**BIOBASE**

**-25°C Freezer  
BDF-25V268/328  
User Manual**

**BIOBASE GROUP**

**Version 2020.08**

## Preface

Thank you for choosing BIOBASE products. For your safety, ease of use and reasonable maintenance of this product, please read the instructions carefully before repair and keep it for inspection.

Damage to any instrument caused by the user's use of the Instrument Environment as stated in this manual, or injury caused by an individual's failure to operate in accordance with the Safety Tips, and is not responsible and liable for this.

Users in the use must do the following three points:

1. Always use protective equipment (including clothes, gloves, goggles, etc.);
2. Always use good health habits, in strict accordance with the product description to operate;
3. Everyone has an obligation to be responsible for his own safety.

Due to the faster update of the product, if the function described in this manual is different from the function of the product you purchased, please take the physical function.

**Content**

Preface..... 1

Content..... 2

Chapter 1.Product appearance and overview..... 3

    1.1 Safety Instruction..... 3

    1.2 Diagram and Introduction..... 5

Chapter 2. Preparation and Attention before Use.....6

    2.1Cautions on Transporting..... 6

    2.2 Cautions on Use.....6

Chapter 3.Installation..... 7

Chapter 4.Use..... 8

Chapter 5. Temperature Adjusting and Setting..... 10

Chapter 6. Alarm code.....12

Chapter 7. Daily Maintenance.....14

Chapter 8. Troubleshooting..... 15

Chapter 9. Technical Data..... 16

Chapter 10. Warranty..... 17

## Chapter 1. Product appearance and overview

### 1.1 Safety Instruction

This User's Manual lists out the important safety regulations, please follow the safety regulations, otherwise, the consequences shall be undertaken by you.

Please follow the cautions and regulations listed in this User's Manual for avoiding possible injury for the operator and any other.

"Caution", "Forbidden" and "Warning" are shown as below:

**!** Items marked with "Warning" are related with the safety of the product and operator, and should be strictly followed.

**⊘** Items marked with "Forbidden" must absolutely be forbidden, otherwise, it may possible cause damage for the storage cabinet or physical safety for the operator.

**⚠** This mark is marked on the cover of high voltage electric appliance for avoiding electric shock, and this cover should be removed by qualified engineer or repair technician.

**!** Please adopt the special power supply (AC 220V-50Hz) listed on the name plate of the equipment. If the voltage is lower than 187V or higher than 242V, please install the 4000W or higher automatic voltage stabilizer for the product. If the power cord should be extended, the sectional area of the extended wire shall not be less than 2mm<sup>2</sup>, and the length should not be longer than 3m. It may possibly cause fire or electric shock if power supply of different voltage or frequency which are not marked on the name plate is used.

**!** The power cord of the storage cabinet has 3-line (grounding) plug, and standard 3-line (grounding) socket. Please do not cut or remove the grounding pin of the power cord under any condition. Please ensure that the plug of power cord tightly inserts into the socket with tight contact, otherwise, it may possibly cause fire.

**!** Please use power socket which is connected with grounding wire for avoiding electric shock. If the power socket is not connected with the ground, please ask the qualified technician to install grounding wire.

**!** It requires installing independent overload and leakage protector at the power supply terminal of this storage cabinet.

**⊘** Do not drill on the surface of the storage cabinet, otherwise, it will seriously influence the cooling performance of the storage cabinet.

**⊘** Do not connect this equipment with the ground through gas pipe, water pipe, telephone wire or lightning rod because above mentioned grounding will cause electric shock or other dangers.

**⊘** Do not use the equipment in the open air. It may possibly cause electric leakage or electric shock if the storage cabinet is wet with rain.

**!** This equipment should only be installed by qualified technician, it may possibly cause electric shock or fire if it is installed by disqualified technician.

**!** Please install the equipment on the solid floor, if the floor is not solid or the installation place is unsuitable, it may possible cause equipment overturn or physical injury.

**⊘** Do not install the equipment in the damp site or place where may easily suffer from water, otherwise, it may cause electric leakage or electric shock since the insulating quality will be dropped.

## BIOBASE

---

- ⊙ Do not store flammable, explosive and dangerous products or volatile materials in the equipment, do not use flammable mist near the equipment, otherwise, it may possibly cause explosion or fire.
- ⊙ Do not store acid, alkali and corrosive materials in this equipment, otherwise, it may possibly damage the internal components or electric parts of the equipment.
- ⊙ Do not insert metal products such as iron nail or wire into any hole and clearance of this equipment or any outlet for internal air circulation, otherwise, it may possibly cause electric shock or physical injury since the above objects may contact with the moving parts.
- ❗ Please use this equipment in the safe area when it is used for toxic, harmful or radioactive materials since incorrect use may possibly cause harm to human health the environment.
- ❗ When there's flammable gas leakage, please turn off the gas valve, open the doors and windows for ventilation, please do not unplug or insert the power plug of the storage cabinet.
- ❗ Please cut off power supply before equipment repair or maintenance for avoiding electric shock or physical injury.
- ❗ Ensure that the repair technician won't inhale medicine or suspended particles in or surrounding this equipment, otherwise, it may possibly cause harm to human health.
- ⊙ Do not directly pour water on the equipment, otherwise, it may cause electric shock or short circuit.
- ⊙ Please do not disassemble, repair or refit this equipment by yourself. Any above work which is not operated by the authorized technician may possibly cause fore or physical injury.
- ❗ If the equipment doesn't work normally, please cut off power supply. It may possibly cause electric shock or fire if it keeps working under abnormal state.
- ❗ If the equipment is kept in the open area for a long period, please ensure that children won't approach the equipment, and the cabinet door should not be closed completely.
- ❗ Please do not supply power within 5 minutes if the power supply of the storage cabinet is cut off, otherwise, it may possibly damage the compressor or system, please unplug the power plug before repairing the equipment. Please do not roll, press or damage the power cord.
- ❗ The abandoned equipment shall be handled by corresponding technician. Remove the cabinet doors for avoiding accident such as suffocation.
- ❗ Please hold the power plug instead of pulling the wire of plug when removing the plug from the power socket, otherwise, it may possibly cause electric shock or fire caused by short circuit.
- ⊙ Please do not contact any electric part or switch such as power plug with wet hand, otherwise, it may possibly cause electric shock.
- ❗ When restart the equipment after power failure or cutting off power supply, please check the settings of the equipment because the change of settings may possibly damage the stored materials.
- ⊙ Please do not put the container with water or heavy object on the equipment, otherwise, it may possibly cause physical injury if the object falls down, and the water may drop the insulation quality and result in electric leakage or electric shock.
- ⊙ Please do not climb on the equipment or put other objects on the equipment, otherwise, it may possible cause physical injury or equipment damage if the equipment turns over.
- ⊙ Please do not store the glass bottle or filling container in the cabinet, otherwise, it may possibly cause physical injury if the container is broken under low temperature.
- ⊙ Please do not directly contact the stored materials with hand, otherwise, it may possibly cause frostbite if hand contacts the frozen material or internal wall of the equipment.
- ❗ Please wear gloves when repairing the equipment for avoiding injury caused by the sharp edge or

corner.

- ❶ If the equipment won't be used for a long period, please unplug the power plug for avoiding electric shock, electric leakage or fire caused by ageing power cord.
- ⦿ Keep plastic bag out of reach of children because plastic bag may possibly cause suffocation.

## 1.2 Diagram and Introduction

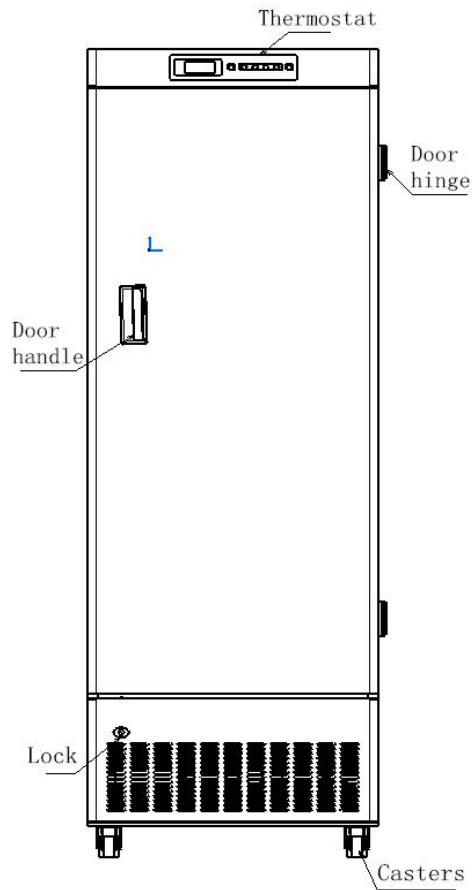

## Chapter 2. Preparation and Attention before Use

### 2.1 Cautions on Transporting

1. Please transport the storage cabinet with forklift or clip charter before unpacking.

If forklift is used, please insert from the bottom of wood support at the side of the storage cabinet and then move the storage cabinet.

If the clip charter is used, please lift from the bottom of wood support, ensure clip the side of the storage cabinet.

2. After unpacking, please push the storage cabinet for moving it.

**Note:** Please do not incline the storage cabinet by over 45° when transporting.

### 2.2 Cautions on Use

- When starting the storage cabinet for the first time or after stopping for a long period, please test the battery, it is possible that the battery is under low power because the battery has been safely discharged, it doesn't mean that there's fault. Under this condition, please fully charge the battery, and keep the storage cabinet working continuously for about 10 hours.
- When the storage cabinet is working, the door frame of the cabinet may be hot, and it is not fault. In order to prevent dew on the enclosure, defrosting pipes are installed around the cabinet.
- Before storing objects in the storage cabinet, please confirm that the temperature has dropped in the cabinet, then put objects in it by batches for avoiding temperature rise.
- The temperature displayed is the temperature at the heat detector in the storing cabinet, although it is possible that there's difference between the displayed temperature and the actual temperature in the middle of the storing cabinet, it will gradually reach the real temperature.
- Please clean the equipment with diluted and PH-balanced detergent (undiluted detergent may damage the plastic parts. Please refer to the instructions of detergent for diluting it). Do not clean the storage cabinet with brush, acid, gasoline, soap powder, polishing powder or hot water, because above materials may possibly hurt the coating surface and plastic and rubber parts. Please do not wipe the plastic and rubber parts with volatile solvent such as gasoline.
- After working for a period, frost may occur on the evaporator, if the frost is thick, it may influence the cooling effect of the storage cabinet and increase electricity consumption, therefore, please cut off power supply to remove frost when the frost is about 5mm thick.
- Before defrosting, please take out the objects from the cabinet and put the objects in the other chamber for avoiding damaging the objects when the temperature rises.
- There're a lot of cooling coils on the rack, please do not remove frost on the rack with sharp tools such as knife, ice chisel or screwdriver. When removing frost, please do not scratch the evaporating pipe, otherwise, it may cause equipment fault.
- If the storage cabinet won't be used for a long period, please cut off power supply and turn off the battery switch.
- In order to reach the best cooling effect, avoid frequently opening the first small door.
- The speed of frosting will be affected by the environment and usage habits, so the defrosting cycle needs to be determined by the user according to the actual situation, and the internal frosting thickness should not be more than 1cm.

## Chapter 3. Installation

### Installation Environment

1. Environment temperature: 5°C~28°C, do not exceed 32°C, the best temperature is 18°C~25°C, please use air conditioning system if necessary.
2. Environment humidity: <80% RH. It shall be lower than 57% RH if the highest work temperature is 32°C.
3. Avoid too much dust.
4. Avoid mechanical sway or vibration.
5. Work Elevation: <2000m.
6. Input Voltage: <220V-±10%.

### Cautions:

1. Because low temperature equipment is relatively sensitive to the environment temperature. If the equipment is installed in other environments and can't work normally, please optimize the environment.
2. It is not allowed to install the equipment in the open environment. It may possibly cause electric leakage or electric shock if the storage cabinet is wet with rain.

### Installation Site

In order to ensure normal work and obtain best performance, the site for installing the equipment shall meet the followings:

1. Do not install it in the small and closed space, the door of the room shall not be less than this product for avoiding difficult repair and storage objects damage when the equipment is fault.
2. Leave at least 30cm gap at four sides of the storage cabinet for ventilation.
3. The floor for installing the equipment must be smooth.
4. The site shall be well ventilated without direct sunlight.
5. Please do not share one socket with other equipment, ensure the plug and socket are connected tightly.
6. Please do not twist or press the power cord.
7. To extend the power cord, the specification of the wire should be 230V-, 15A.
8. Please check the work voltage before use, take it into consideration to use voltage stabilizer in the area with unstable voltage for assuring to stabilize the input voltage at 220V-±10%, the power of the voltage stabilizer shall >3kW.
9. Ensure reliable grounding for this equipment.
10. If the power socket is installed with grounding wire, please check the grounding condition before use.
11. If the socket is not installed with grounding wire, please install grounding wire by qualified technician.
12. Please install the independent overload and leakage protector at the power supply terminal of the storage cabinet.



## Chapter 4.Use

### Installation

1. Remove packing materials and packing bag  
Remove all packing materials and packing bags.
2. Install the position limiting sheet metal  
Install the position limiting sheet metal at the rear side of the machine set.

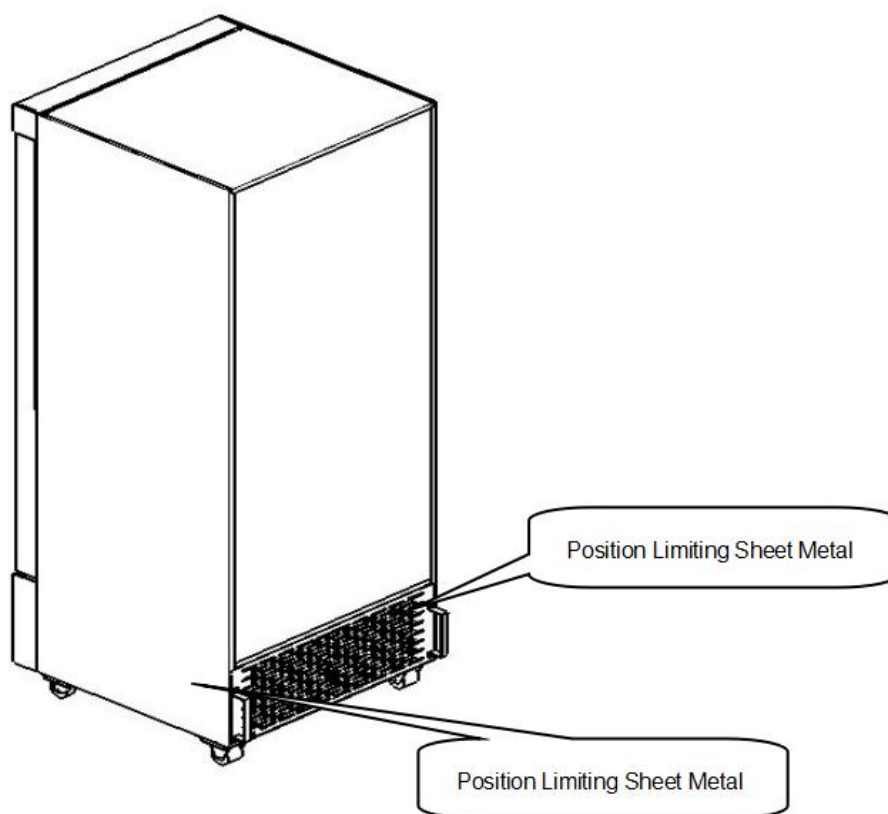

7

### Grounding Warning

Please use power socket with grounding wire. If the socket is not installed with grounding wire, please install grounding wire by qualified technician.

Do not connect this equipment with the ground through gas pipe, water pipe, telephone wire or lightning rod because above mentioned grounding will cause electric shock.

After installing, the power socket must be approachable for conveniently unplug the power cord in emergency. Do not cover the air outlet of the low temperature storage cabinet with any object.

### Adjustment

Please refer to the following steps when use the equipment for the first time:

1. After installing the storage cabinet, please do not supply power within 24 hours.
2. When nothing is stored in the cabinet, connect the power cord with special socket of suitable specification.
3. If there's alarm sound, please press the SET button to stop alarm.
4. Set the desired storage cabinet temperature: when nothing is stored in the cabinet, supply power,

start the cabinet, observe that the storage cabinet may start and stop normally for over 24 hours, which proves that the performance of the storage cabinet is normal.

5. After confirming normal performance of the storage cabinet, please store objects in the storage cabinet.

### **Cautions**

Please arrange full time technician to check and record the working conditions (record once every 2-4 hours), the temperature in the storage cabinet will rise if there's fault or the cabinet is stopped, please take out the objects if it can't be repaired in a short period, and move the objects to the place which meets the requirement on storage temperature for avoiding damaging the objects.

Before storing objects in the cabinet, please confirm that the desired temperature shall be accordant with the temperature range of this product for avoiding damaging the objects and causing loss if the temperature of the product can't reach the requirement.

As a result of cooling inertia, there's difference between the displayed temperature and the setting temperature of the product (the lower the setting temperature, the lower the temperature difference), which is normal.

### **Forbidden**

All low temperature storage cabinets are the storage equipment, it is not allowed to put too much and relatively hot objects into it, otherwise, it may cause constant working of compressor and bad cooling effect, which may easily damage the compressor.

Please do not accelerate the defrosting process with any mechanical tool or other mode which is not approved by the manufacturer.

Do not damage the cooling loop

Do not use the electric appliance which is not approved by the manufacturer in the storage cabinet.

### **Operation after Cutting off Power Supply**

The storage cabinet has memory function for the setting value, after power off, the equipment will work according to the setting parameters before the last power failure.

## Chapter 5. Temperature Adjusting and Setting

### Functions of Buttons

The electronic thermostat is installed in the control panel of the low temperature storage cabinet, after power on, the LCD may display the actual temperature in the cabinet. The control panel of the thermostat is shown as below:

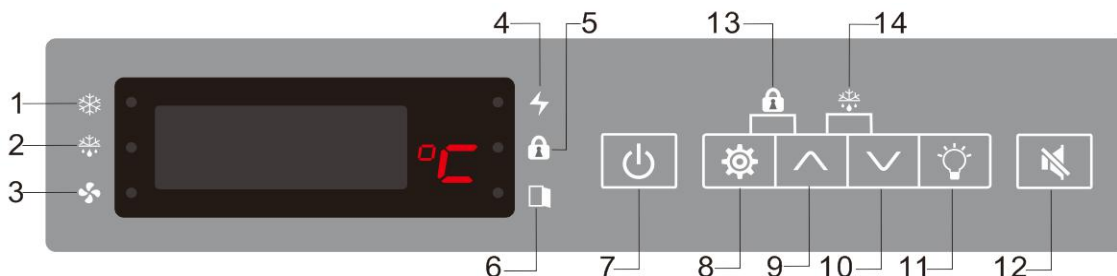

- 1.Cooling Lamp      2.Defrost Lamp      3.Fan Status Lamp      4.Power Lamp
- 5.Keyboard Lock Lamp      6.Door Open Lamp      7.Power Switch      8.Setting      9.Up
- 10.Down      11.Lamp Switch      14.Defrost      12.Mute      13.Keyboard Lock

**Note:** Indicator is not designed for this product, therefore, the indicator button is invalid.

Please do not change the settings when normal using. Long press the power key will switch off the appliance, This appliance does not work. All LED, digital tube off. Long press the power button again, Power supply LCD is lit, the digital tube display the current temperature. Appliance will continue to work properly. Long press the keypad lock key ( combination of keys ) can lock the keypad. The keyboard lock LED are lit, all the keys are failure. Then long press the keypad lock again can be unlocked. Press “Mute” to stop buzzing if necessary when alarmed, but the alarm lamp and code will keep displaying until the alarm disappear. For special using, please contact our authorized service engineer before adjust the settings. Wrong operation may cause abnormal working of the device, such as bad temperature uniformity and abnormal high/low temp alarm. Notes: the general high and low temperature alarm values are within the set temperature range of 2~10 °C.

### Method for Setting Parameters

After power on the low temperature storage cabinet, LCD displays the current temperature in the cabinet, to reset the setting value temperature, for example, the original setting temperature is -5°C, and it requires adjusting it to -20°C, please operate according to the following steps:

Serial No.	Keys Operation	Display
1		Displays the inside temperature
2	Press the key Set  for 3 seconds	Displays the initial set data is -5°C and twinkles
3	Press the key Up-regulation	Figure increases
4	Press the key Down-regulation	Figure decreases
5		Figure is -20°C
6	Press the key Set	Saves the user settings and displays the inside temperature





**Note:** It is suggested not to set the parameters, if the parameters must be modified, please contact our after sale hotline or dealers.









# BIOBASE

---

## Time query settings

When normal working, press  check time record, such as current time is 20:20.21 on the afternoon of Mar 15th,2017.

NO.	key operation	Display
1		display cabinet temperature.
2	Press 	Year Y_17
3	Press again 	Month N_03
4	Press again 	Date D 15
5	Press again 	Minute E 20
6	Press again 	Sencon S 21

Note:When normal display long press  5s,can adjust the current time.when normal display, press  5s,flickering display of Y\_17,through press  or  set current year,then press  flickering display of N\_03,through  or  set the current month,repeat these steps after you have set the time accordingly,long time press  can save time settings.

## Chapter 6. Alarm code

NO.	Alarm code	Describe
1	AH	Sensor high temperature alarm
2	AL	Sensor low temperature alarm
3	AUF	Power failure alarm

After the power is switched off, the control function of the controller fails and the back-up source is used for displaying. If the back-up source is charged for more than 10 hours, the power failure symbol “AUF”, the current inside temperature and the alarm display alternatively for one time and then display again after 1min stop for cycle operation. After 8 hours, the nixie tube stops displaying. The power failure alarm light will 5S twinkle continuously until the electric quantity of the back-up source is used up. The inside temperature can be continuously displayed during the power failure. Please pay attention to this and take relevant measures to avoid damage.

### **Error display**

When faults of the temperature display sensor including short circuit, open circuit, malfunction and incorrect connection appear, “AD1S” is displayed. When faults of the temperature control sensor including short circuit, open circuit, malfunction and incorrect connection appear, “AS1S” is displayed. At the same time, the buzzer of the temperature controller will give out alarm and the display screen displays corresponding alarm parameters (AD1S、AS1S).

After the power is switched off, the control function of the controller fails and the back-up source is used for displaying. If the back-up source is charged for more than 10 hours, the power failure symbol “AUF”, the current inside temperature and the alarm display alternatively for one time and then display again after 1min stop for cycle operation. After 8 hours, the nixie tube stops displaying. The power failure alarm light will 5S twinkle continuously until the electric quantity of the back-up source is used up. The inside temperature can be continuously displayed during the power failure. Please pay attention to this and take relevant measures to avoid damage.

Suggest: If you judge that the temperature sensor goes wrong, you should cut off the power and first check whether the connecting wire of the sensor is loose. Please contact professional after-sales service or distributor of us for processing.

**!** Tips: If internal code appears when user regulates the temperature controller, the user should wait for 1 minute and then operate it till the inside temperature is displayed to avoid fault of the Medical refrigerator caused by the changing of the control parameter.

When the Freezer stops temporarily due to power failure or other faults, the inside temperature of the Medical refrigerator will rise from 5°C to 15°C within 1 hour. If power cannot be supplied in short time, the user should consider taking out the stored goods and putting them into other normal Freezer for storing to avoid losses caused by the damage of the stored goods.

Before putting goods into the Freezer to be stored, the user should confirm in advance that whether inside temperature of the Freezer is in accordance with the set temperature for storing to avoid losses caused by goods damage due to the improper temperature.

Due to the refrigeration inertia, the Freezer cannot be kept at constant temperature. And there is certain up and down difference between the inside temperature and the set temperature. The inside

## **BIOBASE**

---

temperature varies with the changing of the environmental conditions and the temperature set. It belongs to normal phenomenon.

## Chapter 7. Daily Maintenance

Warning: in order to avoid electric shock and physical injury, please cut off power supply of the equipment before repair or maintenance.

Ensure not inhale medicine or suspended particles surrounding this equipment, otherwise, it may possibly cause harm to your health.

### Clean the Storage Cabinet

- Please clean the storage cabinet once a month. It can keep the new appearance of the storage cabinet after periodical cleaning.
- Wipe off dust from the enclosure and internal chamber and all accessories of the storage cabinet. If the storage cabinet is very dirt, please wipe off the dirt with soft fabric after immersing in PH-balanced detergent, and then wipe off the remained detergent with wet fabric, and then wipe with dry fabric. (Undiluted detergent may damage the plastic parts. .Please refer to the instructions of detergent for diluting it.)
- Do not directly pour water on enclosure of the equipment, otherwise, it may possible damage the electric insulation and cause fault.
- The compressor and other mechanical parts are under completely closed state and don't need lubricating.
- Remove the frost or ice from the internal wall once a month.

### Internal Wall Defrosting

Frost may keep on the rack in the cabinet and may possibly cause gap between the cabinet body and door seal and drop the cooling effect, please remove frost after cutting off power supply, the followings are the method for defrosting through blanking the cabinet.

Note: Please do not remove frost with toll of sharp edge such as knife or screwdriver.

1. Take out the objects from the cabinet and store in other storage cabinets or container with frozen liquid carbon dioxide.
2. Cut off power supply.
3. Open the small doors, keep the external door open to defrost for a moment.
4. Remove the water from the bottom of the cabinet with dry fabric.
5. Start the storage cabinet after cleaning the cabinet body.
6. Put the objects into the completely refrigerated cabinet.

## Chapter 8. Troubleshooting

Please check the followings before notifying the repair technician if there's fault:

### **The equipment can't start**

Check if power is correctly connected, if the main power switch is turned on?

Check if the power voltage is too low?

Check if too much objects are stored in the cabinet?

### **Bad cooling effect**

Check if the environment temperature is too high?

Check if the external door is closed? (Frost between the cabinet body and door seal may possibly drop the sealing property of the door)

Check if the temperature is set correctly?

Check if the storage cabinet is far from direct sunlight?

Check if the storage cabinet is near the heat source?

If too much objects are stored in the cabinet within several hours? (Under this condition, the problem is temporary, please rise the setting temperature, stop and start the storage cabinet normally in a short moment to gradually drop the setting temperature.)

### **Noise**

Check if the storage cabinet is installed on the solid floor?

Check if the storage cabinet enclosure contacts any foreign object?

Check if the storage cabinet is working under low temperature state?

If there're too many objects in the cabinet which may cause high temperature, the storage cabinet may make noises sometimes. And the noise will drop as the temperature drops.

Check if the noise is from the compressor (the compressor noise of the low temperature equipment is higher than the compressor of home appliances)

Knock noise. It may possibly cause by the acute cooling and contracting of internal parts, please drop the temperature gradually for avoiding sudden temperature drop in a short moment.



**Chapter 9. Technical Data**

**Specification**

Model	Climate type	Temperature in Cabinet (°C)	Effective Capacity (L)	Rated Voltage /Frequency	Refrigerant	Dimension (W*D*H) mm
<b>BDF-25V268</b>	SN/N	-10~-25	268	AC220V ± 10%, 50/60Hz;110V ± 10%,60Hz	R290	673×676×1630
<b>BDF-25V328</b>	SN/N	-10~-25	328		R290	673×676×1886

**Electric Circuit Diagram**

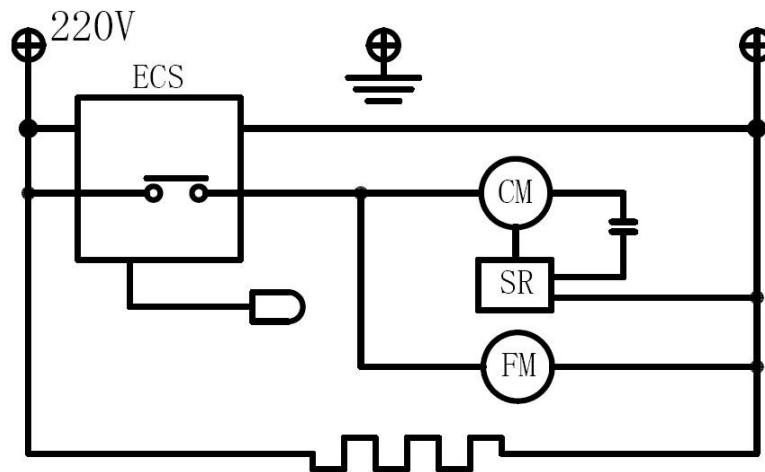

**Packaging List**

Model	User's Manual	Key	Position Limiting Sheet Metal	Shelf	Clip
<b>BDF-25V328</b>	<b>1</b>	<b>2</b>	<b>2</b>	<b>4</b>	<b>16</b>

## Chapter 10. Warranty

1. User can enjoy one-year free warranty for the whole equipment since the purchasing date which bases on the date of the effective receipt.
2. The warranty depends on the certificate and the purchase effective receipt. And during the warranty, the certificate and the purchase effective receipt should be shown simultaneously (customers who are out of the region and need maintenance service should send the certificate and the purchase effective receipt together to BIOBASE).
3. The following conditions are not covered under warranty. For these conditions, we only offer maintenance service and charge labor cost and normal fees.
  - (1) All damages caused by human factors, including operation under improper working environment, damages caused by use not according to the instruction book and malfunction, etc.
  - (2) Disassemble, maintenance and modification without permission, maintenance made by unit having no certificate of incumbency of BIOBASE and lack of warranty card and effective receipt.
  - (3) Damage caused by poor transport of oneself or other irresistible factors (such as flood, fire, lighting stroke and earthquake, etc.) after the purchase.

## **BIOBASE GROUP**

2# building, No.9 Gangxing Road, High-tech Zone, Jinan City, Shandong Province,  
China

Tel: +86-531-81219803/01

Fax: +86-531-81219804

Inquiry: [export@biobase.com](mailto:export@biobase.com)

Complaints: [customer\\_support@biobase.cc](mailto:customer_support@biobase.cc)

After-sales service: [service\\_sd@biobase.cc](mailto:service_sd@biobase.cc); [service\\_ivd@biobase.cc](mailto:service_ivd@biobase.cc)

Web: [www.biobase.cc](http://www.biobase.cc)/[www.meihuatrade.com](http://www.meihuatrade.com) / [www.biobase.com](http://www.biobase.com)